

Application

The FSD-151-OP combination fire smoke damper employs airfoil blades for point-of-origin control of fire and smoke in static and dynamic smoke management systems. These specialty dampers are approved for installation with the closed plane of the blades up to 14½" (368) outside the fire rated partition and come standard with the actuator in the airstream allowing for direct service access from the face of the damper through the HVAC grille. The FSD-151-OP is qualified to 4,000 ft/min (20.3 m/s) and 4 in.wg. (1.0 kPa) and may be installed in vertical walls and partitions, or horizontally in floors or assemblies with fire resistance ratings up to 2 hours.

Standard Construction

Frame: 5" × 1" (127 × 25) galvanized steel hat channel with interlocking corner gusset. Equivalent to 13 gauge (2.4) channel frame. Low profile head and sill are used on sizes less than 13" (330) high.

Blades: 6" × 14 gauge (152 × 2.0) equivalent galvanized — steel airfoil.

Sleeve: 16" × 20 gauge (406 × 1.0) galvanized steel.

Axles: ½" (13) diameter plated steel hex.

Linkage: Concealed in frame.

Bearings: Stainless steel oilite, sleeve-type.

Seals: Silicone blade edge seals integrally rolled and mechanically fastened to blades. Flexible metal jamb seals.

Actuator: 120 VAC, power-open, spring-close, internal mount.

Fire Closure Device: HS-10 (electric actuators)
PFV (pneumatic actuators)

Fire Closure Temperature: 165°F (75°C).

Minimum Size: 10" × 8" (250 × 203)

Maximum Size: 36" × 36" (914 × 914)

Options

- Alternate actuator:
 - External Mount
 - 24 VAC
 - 230 VAC
 - Pneumatic
- DRS-30 — Two temperature fire closure device.
(Includes PI-50 switch package)
- PI-50 — Dual position indicator switch package.
- Alternate factory installed sleeve:
 - Gauge: 18 (1.3) 16 (1.6) 14 (2.0) 10 (3.5)
 - Net O.D. (sleeve I.D. will be approximately ⅜" (9) under nominal duct size opening).
- Transitions: Round Oval
 - Duct connections: 1" (25) S-clip 1½" (38) S-clip
 - DM25 DM35 WARD
- Alternate fire closure temperature:
 - 212°F (100°C) 250°F (121°C)
 - 350°F (177°C).
- Duct smoke detector factory mounted and wired:
 - 2151 (0-3,000 fpm [0-15.2 m/s])
- Remote control stations:
 - RCP-1 (single) RCP-1K (single, key controlled)
 - RCP-1M (single, momentary switch)

Ratings

UL 555 Fire Resistance Rating: 1½ hour (vertical and horizontal)

UL 555S Leakage Class: 1 [8 cfm/sq.ft. @ 4 in.wg.]
[(0.04 m³/s/m² @ 1.0 kPa)]

Maximum Dynamic Closure Velocity: 4,000 fpm (20.3 m/s)

Maximum UL555S Rated Pressure: 4 in.wg. (1.0 kPa)

Maximum Temperature: 350°F (177°C)

Listings

UL 555 and 555S listing: R11767

CSFM listing: 3225-0368:115 and 3230-0368:116

New York City MEA listing: 295-98-E

Meets NFPA Standards: 90A, 92A, 92B and 101

Meets Building Code Standards: IBC, NBC, NFPA, SBC and UBC

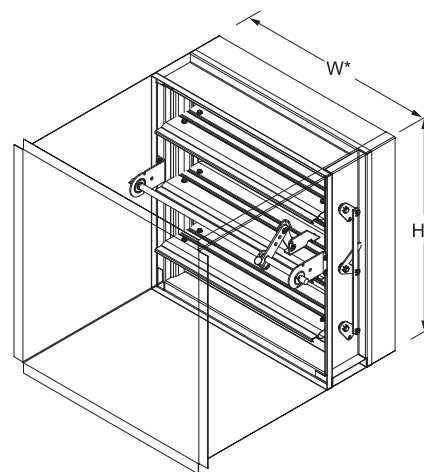

Model **FSD-151-OP** (standard)

*Standard sleeve O.D. including thermal blanket wrap, is approximately ⅜" (9) over nominal duct size. Standard sleeve I.D. is approximately nominal duct size.

NOTE: The opening for the damper assembly in the fire wall must be sized appropriately. If not, serious damage to the thermal blanket wrap could occur and this will nullify the U.L. rating. Contact the factory if necessary for additional information.

Actuator and Sleeve Dimensional Data

The drawings and corresponding table show the position of the damper when mounted in a factory sleeve and the relative space required for a given actuator. The standard mounting locations provide enough space for installation of retaining angles and duct connections.

Actuator Model	X Dimension		Minimum Damper Size (w x h)
FSLF120/24	11" (279) (H < 15")	6" (152) (H ≥ 15")	10" x 8" (254 x 203)
FSNF120/24	14" (356) (H < 18")	11" (279) (H ≥ 18")	10" x 10" (254 x 254)
MS4120/8120	15" (381) (H < 18")	12" (305) (H ≥ 18")	10" x 10" (254 x 254)
ML4115/8115 ML4209/8209	9" (229) (H < 13")	6" (152) (H ≥ 13")	10" x 8" (254 x 203)
331-4826	N/A	8" (203) (H ≥ 20")	10" x 20" (254 x 508)

- NOTE:**
1. Damper may be rotated 180° to position actuator on right side.
 2. For dimensions on actuators not shown above, contact factory.
 3. If actuator is ordered with optional external mount, sleeve flange should be ordered loose, for field assembly.

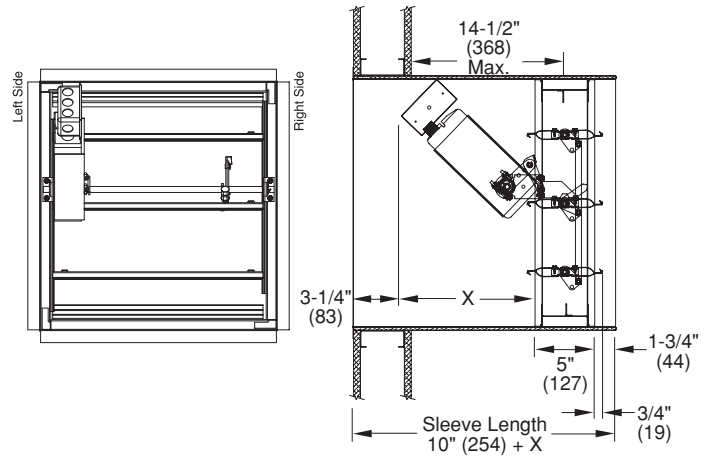

Airflow Performance Data

Pressure Loss vs. Velocity

Figure 5.3 — Ducted Inlet and Outlet

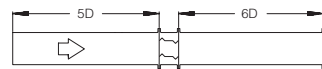
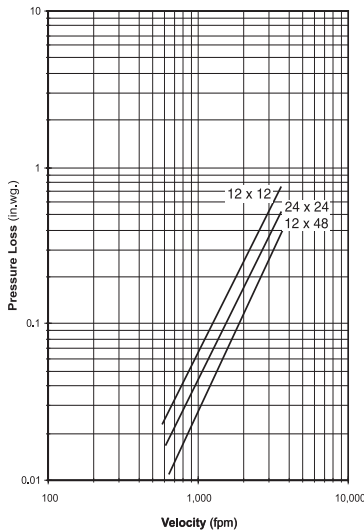

Ducted Inlet and Outlet

AMCA Figure 5.3 illustrates a fully ducted damper. This configuration represents the lowest pressure drop of the three test configurations because entrance and exit losses are minimized by straight duct runs upstream and downstream of the damper.

Figure 5.2 — Ducted Inlet

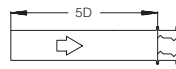
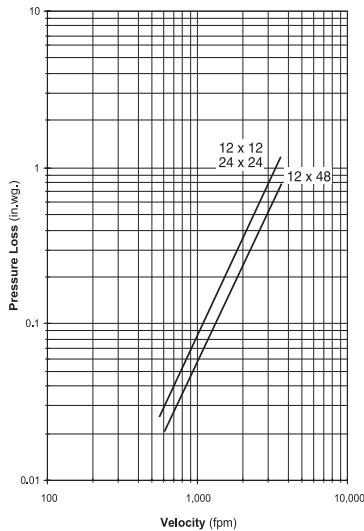

Ducted Inlet

AMCA Figure 5.2 illustrates a ducted damper exhausting air into an open area. This configuration has a lower pressure drop than Figure 5.5 because entrance losses are minimized by a straight duct run upstream of the damper.

Figure 5.5 Plenum Mount

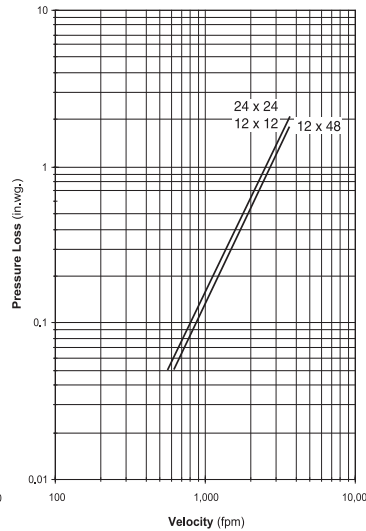

Plenum Mount

AMCA Figure 5.5 illustrates a plenum mounted damper. This configuration has the highest pressure drop because of extremely high entrance and exit losses due to the sudden changes of area in the system.

Pressure drop testing was performed in accordance with AMCA Standard 500-D using the three configurations shown. All data has been corrected to represent air density of 0.075 lb/ft. Actual pressure drop in any ducted HVAC system is a combination of many elements. This information, along with analysis of other system influences, should be used to estimate actual pressure losses for a damper installed in a given HVAC system.