

## Application

The SFK-445 formed steel louver is designed for intake and exhaust application where protection against water infiltration is not critical. The SFK-445 is available in a wide array of painted finishes including custom color matching.

## Standard Construction

**Material:** Galvanized steel.

**Frame:** 4" deep × 20 ga. thick (102 × 1) channel.

**Blades:** 45° × 20 ga. (1) thick K-style.

**Screen:** 1/2" × 0.063" (12.7 × 1.6) expanded and flattened aluminum.

**Mullion:** Visible.

**Minimum Size:** 12" × 12" (305 × 305)

**Maximum Size:** Single section: 60" × 120" (1524 × 3048)  
120" × 60" (3048 × 1524)  
Multiple section: Unlimited

## Options

- Factory finish:
  - Polyester Powder
  - Baked Enamel
  - Prime Coat
- 1 1/2" (38) flange frame.
- Welded construction.
- Alternate bird or insect screens.
- Insulated or non-insulated blank-off panels.
- Filter racks.
- Hinged frame.
- Heavy duty 16 ga. (1.6) construction.
- 304 stainless steel construction.

## Ratings

**Free Area:** [48" × 48" (1222 × 1222) unit]: 7.7 ft<sup>2</sup> (0.72 m<sup>2</sup>)  
48.0%

### Performance @ Beginning Point of Water Penetration

**Free Area Velocity:** 775 fpm (3.94 m/s)  
**Air Volume Delivered:** 5,991 cfm (2.83 m<sup>3</sup>/s)  
**Pressure Loss:** 0.13 in.wg. (32 Pa)

**Velocity @ 0.15 in.wg. Pressure Loss:** 840 fpm (4.26 m/s)

**Design Load:** 30 psf

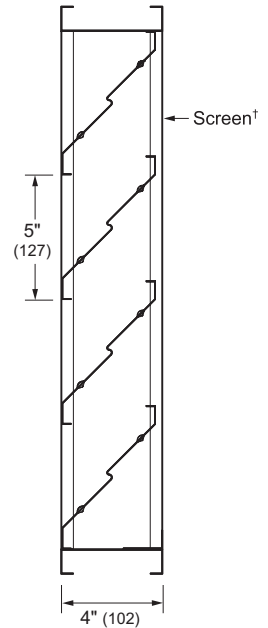
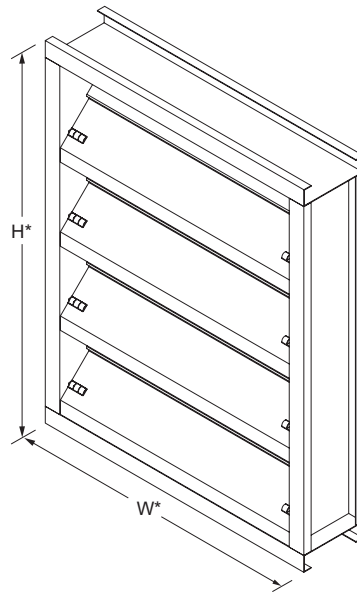

Model **SFK-445**  
(standard)

\*Louvers dimensions furnished approximately 1/2" (13) undersize.

**Vertical Section**

†Screen adds approximately 3/16" (5) to louver depth.

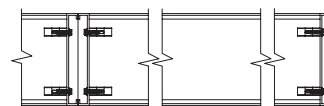

**Vertical Mullion**  
(standard)

Mullion Cover  
(supplied loose for field installation)

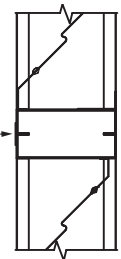

**Horizontal Mullion**  
(standard)

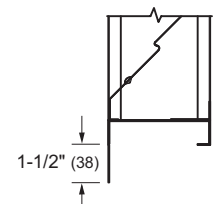

**Flange Frame**  
(optional)

# Performance Data

## Free Area (ft<sup>2</sup>)

		Width (Inches)														
		12	18	24	30	36	42	48	54	60	66	72	78	84	90	96
Height (Inches)	12	0.2	0.3	0.5	0.6	0.7	0.8	1.0	1.1	1.2	1.3	1.5	1.6	1.7	1.8	2.0
	18	0.5	0.8	1.1	1.4	1.6	1.9	2.2	2.5	2.8	3.1	3.3	3.6	3.9	4.9	4.5
	24	0.8	1.2	1.7	2.1	2.6	3.0	3.5	3.9	4.3	4.8	5.2	5.7	6.1	6.6	7.0
	30	0.9	1.4	1.9	2.5	3.0	3.5	4.0	4.5	5.0	5.5	6.1	6.6	7.1	7.6	8.1
	36	1.2	1.9	2.5	3.2	3.9	4.6	5.2	5.9	6.6	7.3	7.9	8.6	9.3	10.0	10.7
	42	1.5	2.3	3.1	4.0	4.8	5.7	6.5	7.3	8.2	9.0	9.8	10.7	11.5	12.3	13.2
	48	1.7	2.7	3.7	4.7	5.7	6.7	7.7	8.7	9.7	10.7	11.7	12.7	13.7	14.7	15.7
	54	1.9	2.9	4.0	5.1	6.1	7.2	8.3	9.3	10.4	11.5	12.6	13.6	14.7	15.8	16.8
	60	2.2	3.4	4.6	5.8	7.1	8.3	9.5	10.8	12.0	13.2	14.4	15.7	16.9	18.1	19.3
	66	2.4	3.8	5.2	6.6	8.0	9.4	10.8	12.2	13.5	14.9	16.3	17.7	19.1	20.5	21.9
	72	2.6	4.0	5.5	6.9	8.4	9.9	11.3	12.8	14.2	15.7	17.2	18.6	20.1	21.5	23.0
	78	2.8	4.5	6.1	7.7	9.3	10.9	12.6	14.2	15.8	17.4	19.0	20.7	22.3	23.9	25.5
	84	3.1	4.9	6.7	8.5	10.2	12.0	13.8	15.6	17.4	19.1	20.9	22.7	24.5	26.3	28.0
	90	3.4	5.3	7.3	9.2	11.2	13.1	15.0	17.0	18.9	20.9	22.8	24.7	26.7	28.6	30.6
96	3.5	5.5	7.5	9.6	11.6	13.6	15.6	17.6	19.6	21.6	23.6	25.7	27.7	29.7	31.7	

## Pressure Loss

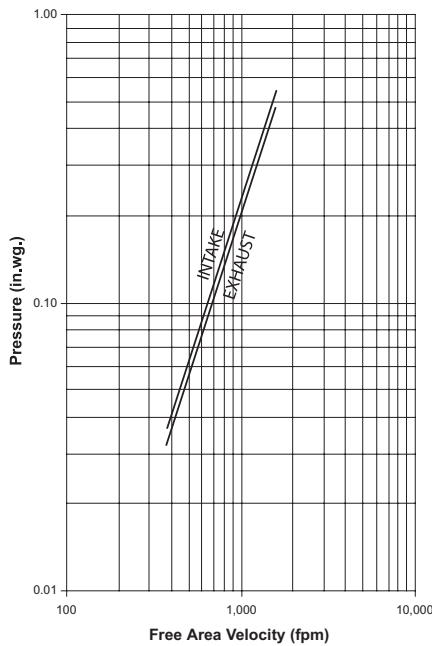

Louver Test Size = 48" x 48" (1219 x 1219)

## Selection Criteria

Follow the steps listed below to calculate the louver size needed to satisfy the required air volume while minimizing the adverse effects of water penetration and pressure loss.

1. Determine the Free Area Velocity (FAV) at the maximum allowable pressure loss using the *Pressure Loss* chart to the left. While job conditions vary, typically, the maximum allowable pressure loss should not exceed 0.15 in.wg., and the FAV for 0.15 in.wg. pressure loss is listed on the front page of this sheet.

2. **Intake Applications** If the FAV at the Beginning Point of Water Penetration (shown below) is less than the FAV from step 1, then use the FAV at the Beginning Point of Water Penetration in step 3, otherwise use the FAV from step 1.

**Exhaust Applications** Use the FAV from step 1 in step 3.

3. Calculate the total louver square footage required using the following equation.

$$\frac{\text{Required Air Volume (cfm)}}{\text{FAV (fpm)}} = \text{Required Louver (Free-Area) Size (ft}^2\text{)}$$

4. Using the *Free Area* chart above, select a louver width and height that yields a free area ft<sup>2</sup> greater than or equal to the required louver size calculated in step 3.

## Water Penetration

Beginning Point of Water Penetration = 775 fpm

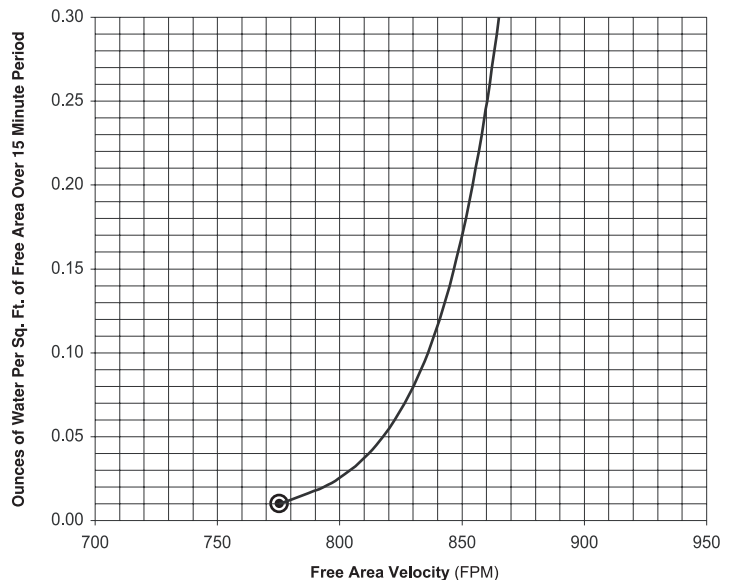

## Water Penetration

AMCA defines the beginning point of water penetration as the free area velocity at the intersection of a simple linear regression of test data and the line of 0.01 ounces of water per square foot of free area and is measured through a 48" x 48" louver during a 15 minute period. The AMCA water penetration test provides a method for comparing louver models and designs as to their efficiency in resisting the penetration of rainfall under specific lab conditions. Pottorff recommends that intake louvers are selected with a reasonable margin of safety below the beginning point of water penetration in order to avoid unwanted penetration during severe storm conditions.