

## Application

The BD-250 backdraft damper employs gravity operated extruded style blades to restrict reverse airflow and to permit the forward flow of air in the intended direction. The BD-250 damper may be mounted vertically or horizontally (airflow up) in either exhaust or intake installations for medium to high velocity and pressure applications.

## Standard Construction

**Frame:** 1-15/16" x 15/16" x 0.125" (49 x 24 x 3) extruded aluminum channel.

**Blades:** 0.07" (1.8) thick aluminum - extruded.

**Linkage:** Exposed on blade.

**Bearings:** Synthetic.

**Seals:** Extruded vinyl blade edge.

**Minimum Size:** 6" x 6" (152 x 152)

**Maximum Size:** Single section: 48" x 52" (1219 x 1321)  
Multiple section: Unlimited

## Options

- Integral 1 1/2" (38) mounting flange.
  - Type B (discharge side)  Type C (intake side)
- Factory installed sleeve:
  - Gauge:  20 (1.0)  16 (1.6)
  - Length:  10" (254)  12" (305)  24" (610)
  - Other \_\_\_\_\_
- Transitions (sleeve required):  Flanged
  - Round AR  Oval AO
- Factory installed internal mount electric actuators:
  - 24VAC  120VAC  230VAC

## Ratings

Damper Width	Maximum System Pressure	Maximum System Velocity
48" (1219)	4 in.wg. (1.0 kPa)	2500 fpm (12.7 m/s)
36" (914)	8 in. wg. (2.0 kPa)	2500 fpm (12.7 m/s)
24" (610)	12 in. wg. (3.0 kPa)	2500 fpm (12.7 m/s)
12" (305)	16 in. wg. (4.0 kPa)	2500 fpm (12.7 m/s)

**Leakage:** 13.3 cfm/ft<sup>2</sup> @ 1.0 in. wg. (0.07m<sup>3</sup>/s/m<sup>2</sup> @ 0.25 kPa)

**Temperature:** -40°F to 200°F (-40°C to 93°C)

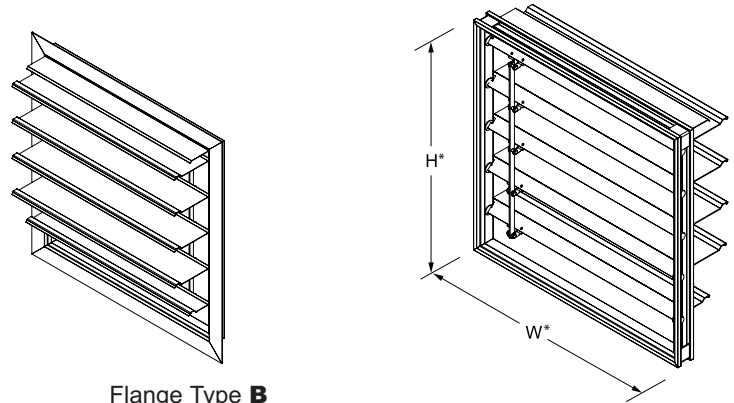

Flange Type **B**  
(discharge side)

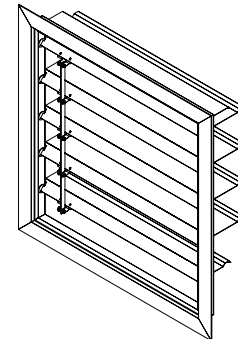

Flange Type **C**  
(intake side)

Model **BD-250**  
(standard)

\* Damper dimensions furnished approximately 1/4" (6) undersize.

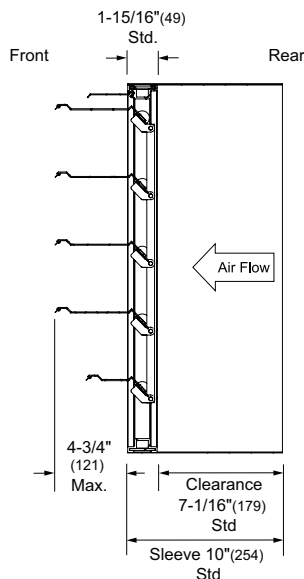

Vertical Mount with Sleeve  
(discharge)

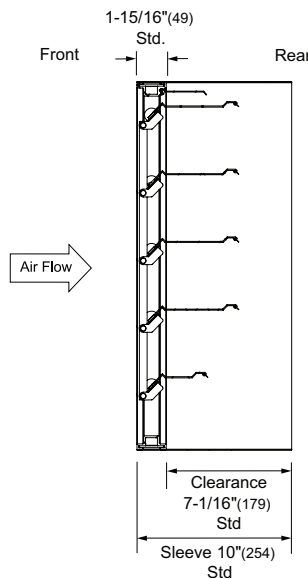

Vertical Mount with Sleeve  
(intake)

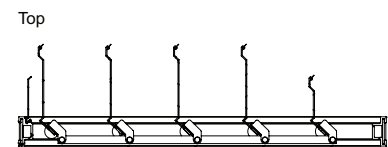

Bottom



Horizontal Mount  
(upflow only)



### Certified Ratings:

Pottorff certifies that the model BD-250 shown herein is licensed to bear the AMCA seal. The ratings shown are based on test and procedures performed in accordance with AMCA Publication 511 and comply with the requirements of the AMCA Certified Ratings Program. The AMCA Certified Ratings seal applies to air performance, and air leakage ratings.

# Airflow Performance Data

## Pressure Drop vs. Velocity

24" x 24" Damper

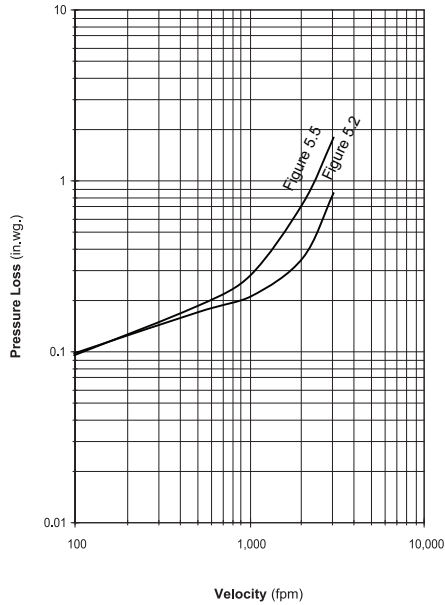

### Certified Ratings:

Pottorff certifies that the model BD-250 shown herein is licensed to bear the AMCA seal. The ratings shown are based on test and procedures performed in accordance with AMCA Publication 511 and comply with the requirements of the AMCA Certified Ratings Program. The AMCA Certified Ratings seal applies to air performance, and air leakage ratings.

Pressure drop testing was performed in accordance with AMCA Standard 500-D using the two configurations shown. All data has been corrected to represent air density of 0.075 lb/ft. Actual pressure drop in any ducted HVAC system is a combination of many elements. This information, along with analysis of other system influences, should be used to estimate actual pressure losses for a damper installed in a given HVAC system.

(AMCA's Certified Ratings Program only allows 24" x 24" backdraft dampers to be tested for certification.)

**NOTE:** Damper blades start to open at 0.03" wg. (7.5 Pa) Damper blades are fully open at 0.27" wg. (68 Pa)

## Leakage vs. Pressure Drop

24"x 24" Damper

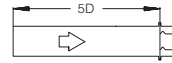
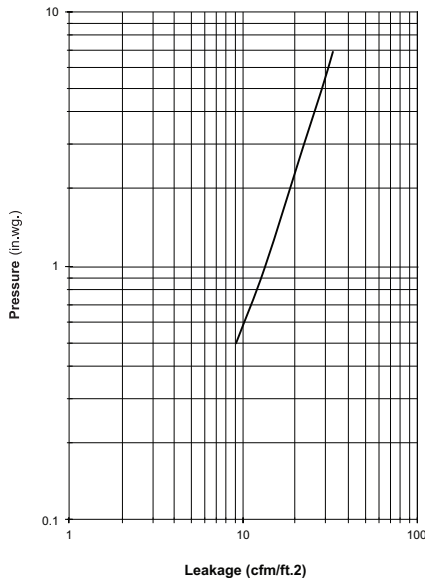

### Ducted Inlet

AMCA Figure 5.2 illustrates a ducted damper exhausting air into an open area. This configuration has a lower pressure drop than Figure 5.5 because entrance losses are minimized by a straight duct run upstream of the damper.



### Plenum Mount

AMCA Figure 5.5 illustrates a plenum mounted damper. This configuration has the highest pressure drop because of extremely high entrance and exit losses due to the sudden changes of area in the system.

Leakage testing was conducted in accordance with ANSI/AMCA 500-D, Figure 5.5, in the intake direction. Data are based on a vertically mounted damper, with gravity used as the only closing torque. Air leakage is based on operation between 32°F (0°C) and 120°F (49°C) and converted to standard air density.

## Installation

1. Dampers must be installed square and free from racking.
2. When installed in a fan discharge application, the damper should be installed a minimum of 1/2 of the fan diameter dimension away from the fan.
3. Dampers are designed to be self-supporting in the maximum single section size. When dampers are installed in multiple section assemblies, bracing may be required to support the weight of the dampers and to ensure structural integrity against system pressures. It is recommended that multiple sections be appropriately braced. In horizontal installations, it is recommended that suitable supports be installed every 8 feet of damper width. Dampers installed in vertical multiple assemblies and/or higher system pressures, may require additional bracing.
4. See Model BD and CBD Installation Instructions for further installation details.

Information is subject to change without notice or obligation.

**NOTE:** Dimensions in parentheses ( ) are millimeters.