

Application

The ECD-745 offers exceptional protection against wind-driven rain under the most severe conditions and is ideally suited for high wind areas or applications that are sensitive to wind-driven rain penetration. The ECD-745 incorporates horizontal blades and is available in a wide array of anodized and painted finishes including custom color matching.

Standard Construction

Material: Mill finish 6063-T5 extruded aluminum.

Frame: 7" deep × 0.081" thick (178 × 2) channel.

Blades: 45° × 0.081" (2) thick horizontal style.

Screen: 1/2" × 0.063" (12.7 × 1.6) expanded and flattened aluminum.

Mullion: Visible.

Minimum Size: 4.5" × 6.5" (114 × 165)

Maximum Size: Single section: 60" × 120" (1524 × 3048)
120" × 60" (3048 × 1524)
Multiple section: Unlimited

Options

- Factory finish:
 - High Performance Fluoropolymer - 100% resin Newlar®/70% resin Kynar®
 - Baked Enamel
 - Clear or Color Anodized, Class 1
 - Prime Coat
- Hidden vertical mullion for continuous blade appearance.
- 1 1/2" (38) flange frame.
- Welded construction.
- Alternate bird or insect screens.
- Insulated or non-insulated blank-off panels.
- Filter racks.
- Hinged frame.
- Head and/or sill flashing.

Ratings

Free Area: [48" × 48" (1222 × 1222) unit]: 8.4 ft² (0.78 m²)
52.5%

Performance @ Beginning Point of Water Penetration

Free Area Velocity: 1,197 fpm (6.08 m/s)
Air Volume Delivered: 10,018 cfm (4.73 m³/s)
Pressure Loss: 0.50 in.wg. (124 Pa)

Velocity @ 0.15 in.wg. Pressure Loss: 620 fpm (3.15 m/s)

Design Load: 30 psf

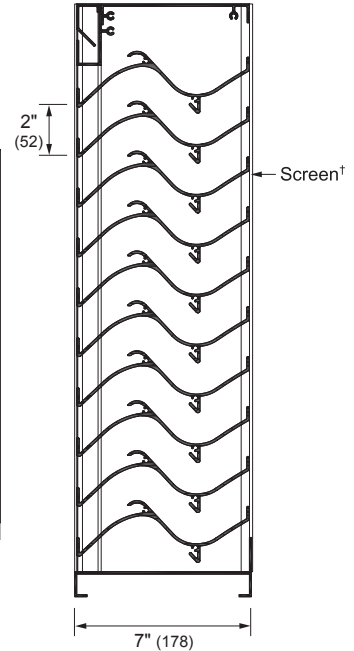
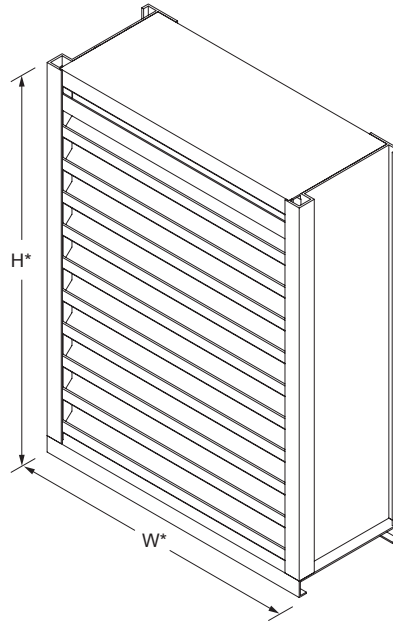

Model **ECD-745**
(standard)

*Louver dimensions furnished approximately 1/2" (13) undersize.

Vertical Section
†Screen adds approximately 3/16" (5) to louver depth.

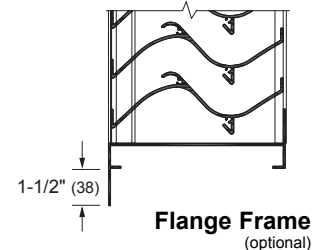
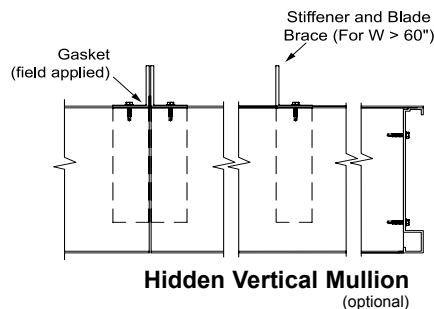
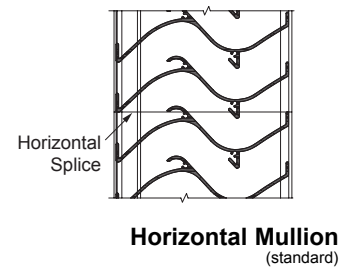
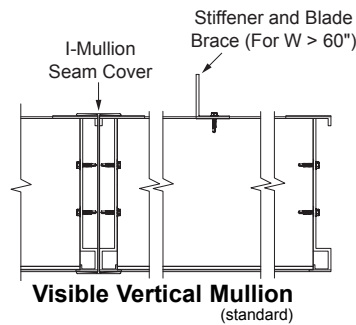

Certified Ratings:

Pottorff certifies that the model ECD-745 shown herein is licensed to bear the AMCA seal. The ratings shown are based on test and procedures performed in accordance with AMCA Publication 511 and comply with the requirements of the AMCA Certified Ratings Program. The AMCA Certified Ratings seal applies to air performance, water penetration and wind-driven rain ratings.

Performance Data

Free Area (ft²)

Height (Inches)	Width (Inches)																		
	12	18	24	30	36	42	48	54	60	66	72	78	84	90	96	102	108	114	120
12	0.3	0.5	0.7	0.9	1.1	1.3	1.5	1.7	1.9	2.1	2.3	2.5	2.7	2.9	3.1	3.3	3.5	3.7	3.9
18	0.6	0.9	1.3	1.6	2.0	2.3	2.7	3.0	3.4	3.7	4.1	4.4	4.8	5.1	5.5	5.8	6.2	6.5	6.9
24	0.8	1.3	1.8	2.3	2.8	3.3	3.8	4.3	4.8	5.3	5.8	6.3	6.8	7.3	7.8	8.3	8.8	9.3	9.8
30	1.1	1.7	2.4	3.0	3.7	4.3	5.0	5.6	6.2	6.9	7.5	8.2	8.8	9.5	10.1	10.8	11.4	12.1	12.7
36	1.3	2.1	2.9	3.7	4.5	5.3	6.1	6.9	7.7	8.5	9.3	10.1	10.9	11.7	12.4	13.2	14.0	14.8	15.6
42	1.6	2.5	3.5	4.4	5.3	6.3	7.2	8.2	9.1	10.1	11.0	11.9	12.9	13.8	14.8	15.7	16.7	17.6	18.5
48	1.8	2.9	4.0	5.1	6.2	7.3	8.4	9.5	10.5	11.6	12.7	13.8	14.9	16.0	17.1	18.2	19.3	20.4	21.5
54	2.1	3.3	4.5	5.8	7.0	8.3	9.5	10.7	12.0	13.2	14.5	15.7	16.9	18.2	19.4	20.7	21.9	23.1	24.4
60	2.3	3.7	5.1	6.5	7.9	9.3	10.6	12.0	13.4	14.8	16.2	17.6	19.0	20.4	21.8	23.1	24.5	25.9	27.3
66	2.6	4.1	5.6	7.2	8.7	10.2	11.8	13.3	14.9	16.4	17.9	19.5	21.0	22.5	24.1	25.6	27.1	28.7	30.2
72	2.8	4.5	6.2	7.9	9.5	11.2	12.9	14.6	16.3	18.0	19.7	21.3	23.0	24.7	26.4	28.1	29.8	31.5	33.1
78	3.1	4.9	6.7	8.6	10.4	12.2	14.1	15.9	17.7	19.6	21.4	23.2	25.1	26.9	28.7	30.6	32.4	34.2	36.1
84	3.3	5.3	7.3	9.3	11.2	13.2	15.2	17.2	19.2	21.1	23.1	25.1	27.1	29.1	31.1	33.0	35.0	37.0	39.0
90	3.6	5.7	7.8	9.9	12.1	14.2	16.3	18.5	20.6	22.7	24.9	27.0	29.1	31.2	33.4	35.5	37.6	39.8	41.9
96	3.8	6.1	8.4	10.6	12.9	15.2	17.5	19.8	22.0	24.3	26.6	28.9	31.1	33.4	35.7	38.0	40.3	42.5	44.8
102	4.0	6.5	8.9	11.3	13.8	16.2	18.6	21.0	23.5	25.9	28.3	30.7	33.2	35.6	38.0	40.5	42.9	45.3	47.7
108	4.3	6.9	9.4	12.0	14.6	17.2	19.7	22.3	24.9	27.5	30.1	32.6	35.2	37.8	40.4	42.9	45.5	48.1	50.7
114	4.5	7.3	10.0	12.7	15.4	18.2	20.9	23.6	26.3	29.1	31.8	34.5	37.2	40.0	42.7	45.4	48.1	50.9	53.6
120	4.8	7.7	10.5	13.4	16.3	19.2	22.0	24.9	27.8	30.6	33.5	36.4	39.3	42.1	45.0	47.9	50.8	53.6	56.5



Certified Ratings:
Pottorff certifies that the model ECD-745 shown herein is licensed to bear the AMCA seal. The ratings shown are based on test and procedures performed in accordance with AMCA Publication 511 and comply with the requirements of the AMCA Certified Ratings Program. The AMCA Certified Ratings seal applies to air performance, water penetration and wind-driven rain ratings.

Pressure Loss

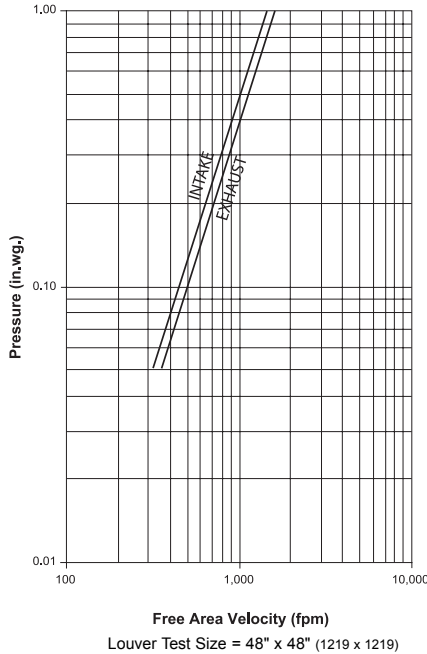

Selection Criteria

Follow the steps listed below to calculate the louver size needed to satisfy the required air volume while minimizing the adverse effects of water penetration and pressure loss.

1. Determine the Free Area Velocity (FAV) at the maximum allowable pressure loss using the *Pressure Loss* chart to the left. While job conditions vary, typically, the maximum allowable pressure loss should not exceed 0.15 in.wg., and the FAV for 0.15 in.wg. pressure loss is listed on the front page of this sheet.
2. **Intake Applications** If the FAV at the Beginning Point of Water Penetration (shown below) is less than the FAV from step 1, then use the FAV at the Beginning Point of Water Penetration in step 3, otherwise use the FAV from step 1.
3. Calculate the total louver square footage required using the following equation.

$$\frac{\text{Required Air Volume}}{\text{FAV}} \text{ cfm} + \frac{\text{Required Louver (Free-Area) Size in ft}^2}{\text{FAV}} \text{ fpm} = \text{Required Louver (Free-Area) Size in ft}^2$$

4. Using the *Free Area* chart above, select a louver width and height that yields a free area ft² greater than or equal to the required louver size calculated in step 3.

Water Penetration

Beginning Point of Water Penetration = 1,197 fpm

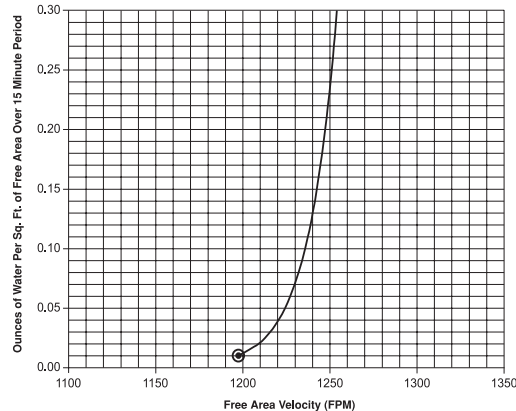

Water Penetration

AMCA defines the beginning point of water penetration as the free area velocity at the intersection of a simple linear regression of test data and the line of 0.01 ounces of water per square foot of free area and is measured through a 48" x 48" louver during a 15 minute period. The AMCA water penetration test provides a method for comparing louver models and designs as to their efficiency in resisting the penetration of rainfall under specific lab conditions. Pottorff recommends that intake louvers are selected with a reasonable margin of safety below the beginning point of water penetration in order to avoid unwanted penetration during severe storm conditions.

Wind Driven Rain Performance — AMCA 500-L Wind Driven Rain Test

Test louver Core Area₁ is 39³/₈" x 39³/₈".

Wind Velocity	Rainfall	Airflow	Core Velocity	Effectiveness Ratio	Wind Class ₂	Discharge Class ₃
29 mph	3 in/hr	7244 cfm	493 fpm	99.9%	A	4

Wind Driven Rain Class	Effectiveness	Discharge Loss Class	Coefficient
A	1.000 to 0.99	1	0.4 to 1.000
B	0.989 to 0.95	2	0.3 to 0.399
C	0.949 to 0.80	3	0.2 to 0.299
D	0.799 to 0.00	4	0.0 to 0.199

NOTES 1. Core Area is the open area of the louver face (face area less louver frame). 2. Wind Driven Rain Penetration Classes. 3. Discharge Loss Coefficient is calculated by dividing the louvers' actual airflow rate by the theoretical airflow rate for an unobstructed opening. The higher the coefficient the lower the resistance to air flow.