

Application

CD-53 and CD-54 control dampers employ narrowline aluminum airfoil blades that operate within an aluminum channel frame for automatic air control and manual balancing in low to medium pressure and velocity applications.

Standard Construction

Frame: 4" x 1" x 0.081" minimum (102 x 25 x 2.1) extruded aluminum channel.

Blades: 4" (102) heavy gauge dual wall extruded aluminum — airfoil. Parallel (model CD-53) or opposed (model CD-54) action.

Axles: 1/2" (13) diameter plated steel hex.

Linkage: Concealed in frame.

Bearings: Synthetic.

Seals: PVC blade edge seals and flexible metal jamb seals.

Control Shaft: 1/2" x 6" (13 x 152) drive axle with outboard shaft support bracket and bearing supplied on all dampers for field installation.

Minimum Size: CD-53 (one blade): 6" x 6" (152 x 152)
CD-53 and CD-54 (two blades): 6" x 9" (152 x 229)

Maximum Size: Single section: 60" x 72" (1524 x 1829)
Multiple sections: 120" (3048) x unlimited height

Options

- Factory installed external mount actuator:
 - Manual locking quadrant (supplied loose)
 - 24 VAC 120 VAC 230 VAC
 - Pneumatic Modulating
- Factory installed sleeve:
 - Gauge: 20 (1.0) 18 (1.3) 16 (1.5) 14 (2.0) 10 (3.5)
 - Length: 12" (305) 16" (406) 24" (610) Other ____
- Side Plate 12" (305) wide.
- Transitions (sleeve required): Flanged
 - Round Oval
 - Duct connections: DM-25 DM-35 S & Drive
- Actuator/Quadrant standoff bracket — accommodates up to 3" (76) thick insulated duct.
- Stainless steel oilite sleeve-type bearings.
- Vertical mounted blades with thrust washers.
- Face and by-pass assemblies:
 - Model MDFBR Model MDFBH Model MDFBV

Ratings

Damper Width	Maximum System Pressure	Maximum System Velocity
12" (305)	10.0 in. wg (2.5 kPa)	6000 fpm (30.5 m/s)
24" (610)	8.4 in. wg (2.1 kPa)	5000 fpm (25.4 m/s)
36" (914)	7.0 in. wg (1.8 kPa)	4000 fpm (20.3 m/s)
48" (1219)	5.5 in. wg (1.4 kPa)	3500 fpm (17.8 m/s)
60" (1524)	3.5 in. wg (0.9 kPa)	3000 fpm (15.2 m/s)

Leakage: 7.0 cfm/ft² @ 10.0 in. wg (0.04m³/s/ m² @ 2.50 kPa)
6.0 cfm/ft² @ 7.0 in. wg (0.03m³/s/ m² @ 1.70 kPa)
4.0 cfm/ft² @ 4.0 in. wg (0.02m³/s/ m² @ 0.90 kPa)

Temperature: -10°F to 150°F (-23°C to +66°C)

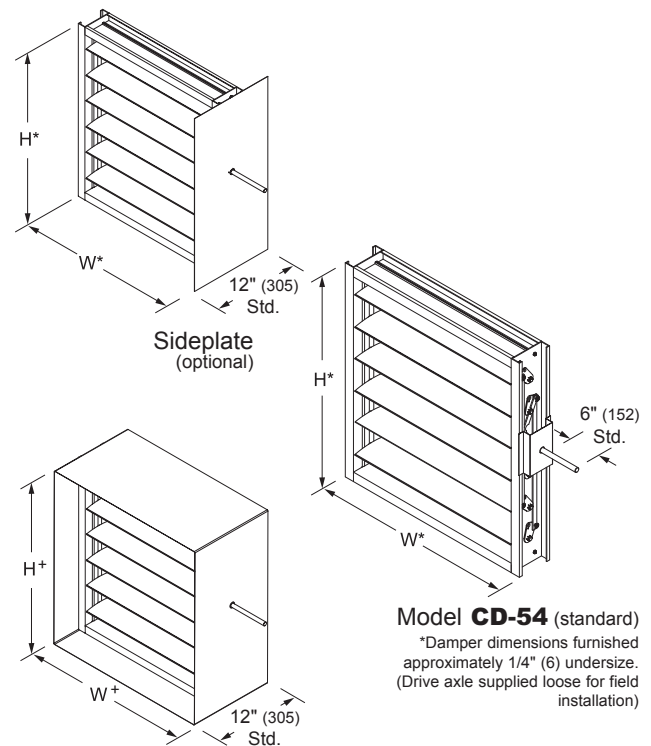

Model CD-54 (standard)
*Damper dimensions furnished approximately 1/4" (6) undersize. (Drive axle supplied loose for field installation)

Sleeve (optional)
*Damper dimensions furnished approximately 1/4" (6) undersize (sleeve thickness not included).

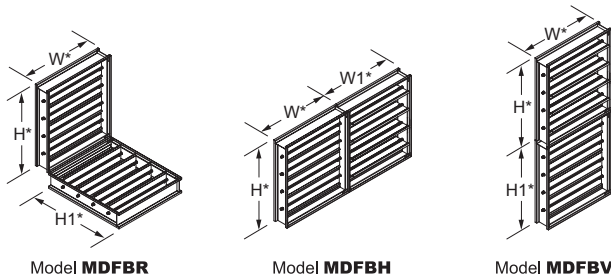

Model **MDFBR**

Model **MDFBH**

Model **MDFBV**



CD-53



CD-54

*Damper dimensions furnished approximately 1/8" (3) undersize.

Information is subject to change without notice or obligation.

NOTE: Dimensions in parentheses () are millimeters.

Airflow Performance Data

Pressure Limitations

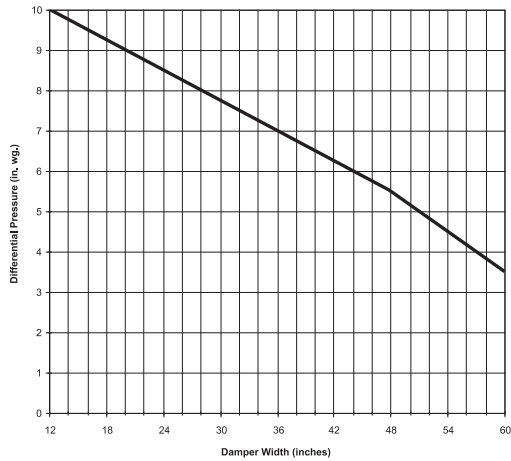

Velocity Limitations

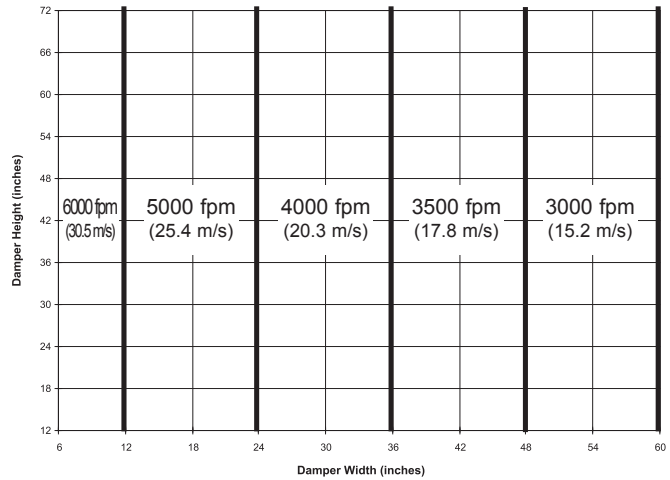

Pressure Loss vs. Velocity

Figure 5.3 — Ducted Inlet and Outlet

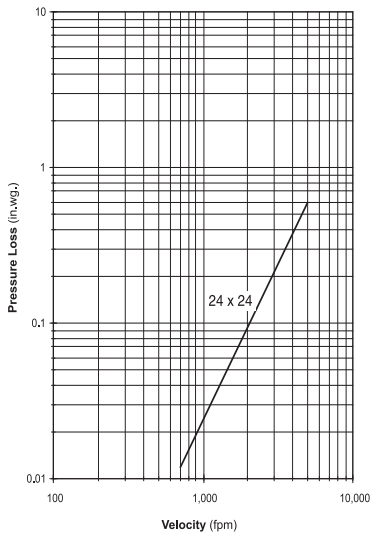

Figure 5.2 — Ducted Inlet

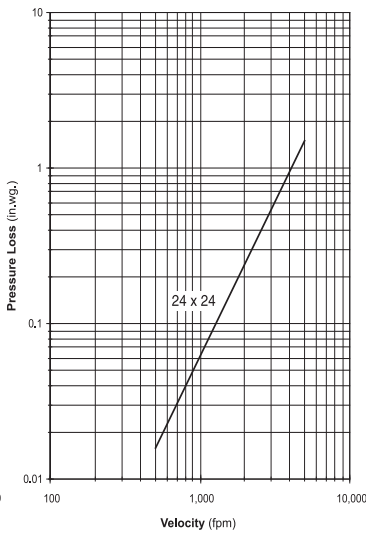
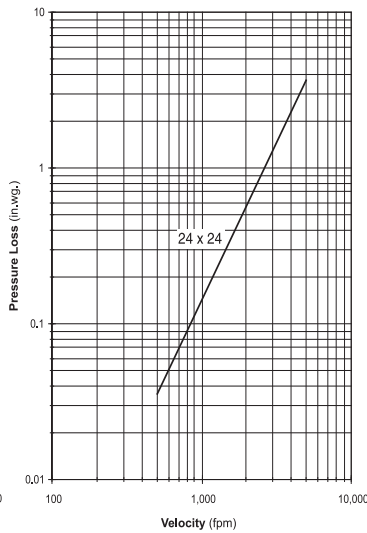
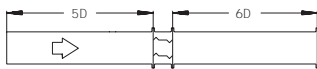

Figure 5.5 Plenum Mount



Pressure drop testing was performed in accordance with AMCA Standard 500-D using the three configurations shown. All data has been corrected to represent air density of 0.075 lb/ft. Actual pressure drop in any ducted HVAC system is a combination of many elements. This information, along with analysis of other system influences, should be used to estimate actual pressure losses for a damper installed in a given HVAC system.



Ducted Inlet and Outlet

AMCA Figure 5.3 illustrates a fully ducted damper. This configuration represents the lowest pressure drop of the three test configurations because entrance and exit losses are minimized by straight duct runs upstream and downstream of the damper.

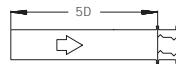

Ducted Inlet

AMCA Figure 5.2 illustrates a ducted damper exhausting air into an open area. This configuration has a lower pressure drop than Figure 5.5 because entrance losses are minimized by a straight duct run upstream of the damper.



Plenum Mount

AMCA Figure 5.5 illustrates a plenum mounted damper. This configuration has the highest pressure drop because of extremely high entrance and exit losses due to the sudden changes of area in the system.