

The following installation details apply to models **CFD-521, CFD-521-IP and CFD-521-NP**

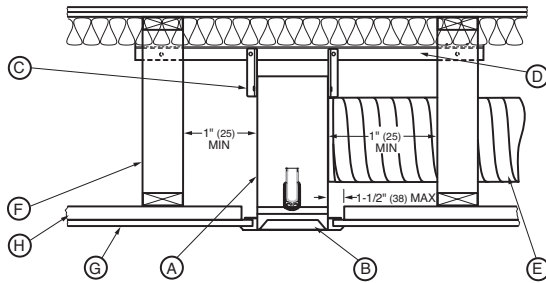

END VIEW - Duct to Grille Connection

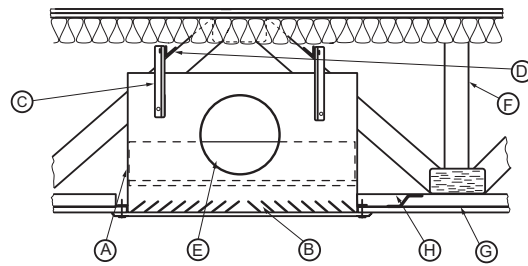

FACE VIEW

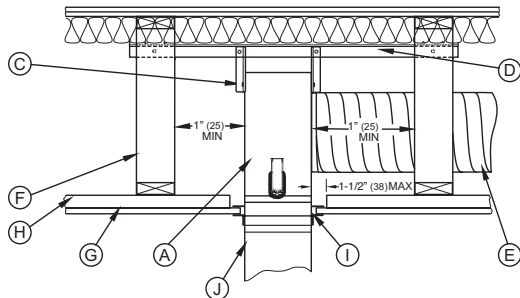

END VIEW - Duct to Duct Connection

- (A) Damper Assembly
- (B) Grille (0.025 steel min)
- (C) $\frac{3}{4}$ " x $\frac{3}{4}$ " x 26 GA. (16 x 16 x 0.55) or 18 swg steel wire (min)
- (D) $\frac{3}{4}$ " x $\frac{3}{4}$ " x 26 GA. (16 x 16 x 0.55) or 2" x 4" (51 x 102) wood stud support
- (E) Flex Duct UL Classified Air Duct (class 0 or 1)
- (F) Wood Truss (see UL design # L-521, L-546 or P-522)
- (G) $\frac{5}{8}$ " (16) Gypsum Wallboard (see UL design # L521 L-546 or P-522)
- (H) RC-Channel
- (I) 1" x 1" x 22 ga. (25 x 25 x 0.85) retaining angle (min)
- (J) Air Duct

Illustrations show model **CFD-521** damper, model **CFD-521-IP** similar.

- A.** Ceiling penetrations should be located between adjacent trusses and between RC-channels without necessitating cuts in the RC-channel. If required, a maximum of one RC-channel may be cut to enable proper damper location and installation. The maximum clearance between the damper sleeve and the edges of the cutout in the ceiling material shall not exceed $\frac{1}{8}$ " (3) on any side.
- B.** The grille shall be fastened to the damper assembly using minimum No.8 screws. This is typically accomplished by securing the face of the grille to the recessed plaster ground flange of the damper, thus sandwiching the $\frac{5}{8}$ " (16) gypsum wallboard between the two. Use a minimum of two connections, one at each end. In place of a grille, an air duct may be connected to the bottom of the dampers. In this case a minimum 1" x 1" x 22 ga. (25 x 25 x 0.85) angle on all four sides of the opening shall be mechanically fastened to the air duct so as to sandwich the $\frac{5}{8}$ " (16) gypsum wallboard between the angle and the plaster ground flange.
- C1.** Damper shall be supported with a minimum $\frac{3}{4}$ " x $\frac{3}{4}$ " x 26 ga. (18 x 18 x 0.55) vertical angle or 18 swg vertical hanger wire, in two places minimum, on opposite sides of the damper. The vertical angle or wire shall in turn be supported by a minimum $\frac{3}{4}$ " x $\frac{3}{4}$ " x 26 ga. (18 x 18 x 0.55) horizontal angle or nominal 2" x 4" (51 x 102) wood support studs. The horizontal support angles or studs shall be fastened at each end to adjacent trusses with minimum 16d nails, No. 8 screws or bolts. Only one connection per end required. For models CFD-521-IP & NP boot rails may be used in place of angles or hanger wire. See sheet IICFD-521-BT.
- C2.** CFD-521-IP & CFD-521-NP damper shall be supported with a 18 swg vertical hanger wire, in two places minimum, on opposite sides of the damper. The vertical angle or wire shall in turn be supported by a minimum $\frac{3}{4}$ " x $\frac{3}{4}$ " x 26 ga. (18 x 18 x 0.55) horizontal angle or nominal 2" x 4" (51 x 102) wood support studs. The horizontal support angles or studs shall be fastened at each end to adjacent trusses with minimum 16d nails, No.8 screws or bolts. Only one connection per end required.

When the damper is installed in a roof/ceiling, horizontal supports shall be installed so that the damper can be properly secured. These horizontal supports can be 2" x 4" (51 x 102) wood studs or $\frac{3}{4}$ " x $\frac{3}{4}$ " x 26 ga. (18 x 18 x .055) steel angles. These supports are to be attached to adjacent truss members provided they are a minimum of 17- $\frac{3}{8}$ " (441) above the underside of the ceiling. As an alternate, the horizontal members can be attached directly to the underside of the roof or roof/truss provided that they are a minimum of 17- $\frac{3}{8}$ " (441) above the underside of the ceiling.

- NOTE:** The addition of the horizontal supports must not interfere nor shall they infringe upon the structural capabilities of the truss system.
- D.** Flex duct shall be UL Classified Air Ducts Class 0 or Class I. In each case, a steel clamp, plastic strap or 18 swg minimum steel wire shall fasten the flex duct to the duct connection portion of the damper assembly.
- NOTE:** CFD-521-IP and CFD-521-NP damper blades must close a maximum of 3- $\frac{1}{2}$ " (89) above gypsum wall board. CFD-521 damper blades must close a maximum of 1- $\frac{5}{8}$ " (35) above gypsum wall board.
- NOTE:** For dampers featuring multiple duct connections, damper blades must close a maximum of $\frac{1}{8}$ " (3) above gypsum wall board.
- NOTE:** Screws, bolts, rivets, etc., used to install the damper or grille **MUST NOT INTERFERE WITH DAMPER BLADE OPERATION.**

For installation in floor-ceiling designs L-521, L-528, L-546, L-558, L-562, L-574, L-576, L-581, L-583, L-585, M-509, M-540 and in roof/ceiling designs P-522, P-533, P-538, P-545, P-547, P-579 and P-580. See UL Fire Resistance Directory.

Underwriter's Laboratories file #R14603.

The product is also listed by CSFM fire #3226-0368:104 and conforms to NFPA 90A and NFPA 92A. Warnock Hersey File # WHI-495-PSH-0177,-0178

Information is subject to change without notice or obligation.

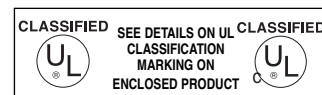

U.L. FILE # R14603



The following installation details apply to models **CFD-521**, **CFD-521-IP** and **CFD-521-NP**

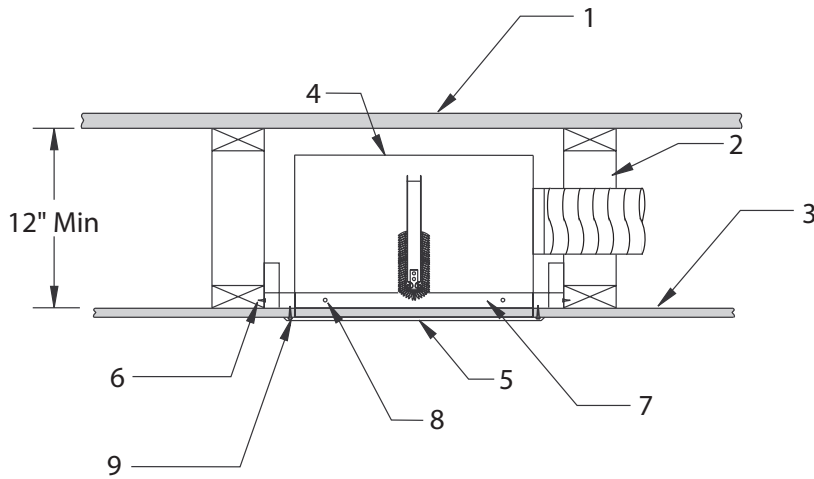

Warnock Hersey Listed
WHI-495-PSH-0177,-0178

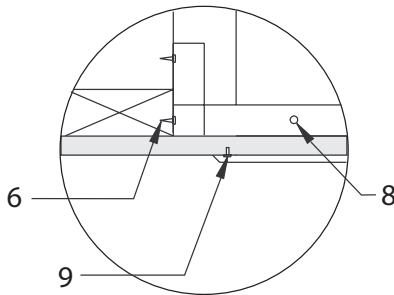

ITEM:	DESCRIPTION
1	Roof/Floor Construction
2	Wood Framing Member or Joist
3	5/8" Gypsum Wallboard
4	Damper
5	Grille (Steel or Aluminum)
6	#6 Penny Nail or #8 Screw (Min. 1/2" long)
7	1" x 1/2" 20 Gauge Galv. Mounting Angle
8	#8 Tek Screw (Min. 1/2" long)
9	Ø3/16 Steel Rivet or Screw

Note: Use of RC channel (not shown) is optional.

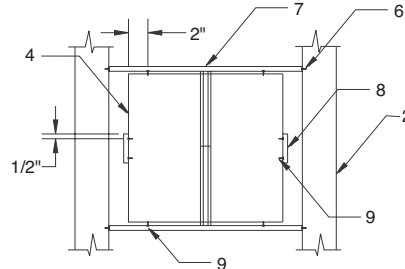
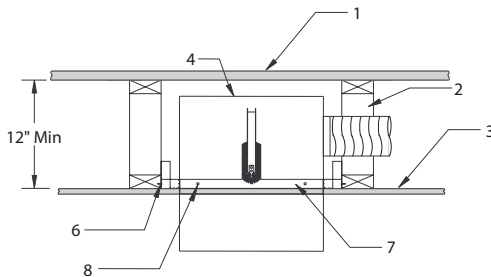

Damper with Extended Sleeve

Illustrations show model **CFD-521** damper, model **CFD-521-IP** and **CFD-521-NP** similar.

- Measure the actual spacing between the wood framing members and cut the mounting angle to that length plus six inches. Two mounting angles are required. Fold up approximately three inches at 90° at both ends of the mounting angle and attach it to the wood frame with minimum of two each #6 penny nails or #8 screws.
- The damper is attached to the mounting angle by sheet metal screws starting at two inches from the end of the damper. A minimum of two screws per angle is required.
- On the sides opposite the retaining angles, a three inch long mounting angle is required. A minimum of two screws per angle is required. Bottom leg of mounting angle should rest on the ceiling material.