

Application

The VV-400 equipment screen incorporates a vertical sight-proof blade for total concealment. The VV-400 is available in a wide array of finishes including custom color matching.

Standard Construction

Material: Mill finish 6063-T5 extruded aluminum.

Frame: 2" × 1½" × 0.081" thick (51 × 38 × 2) angle.

Blades: 0.081" (2) thick vertical V-style.

Mullion: Visible.

Minimum Size: 12" × 12" (305 × 305)

Maximum Size: Single section: 72" × 144" (1829 × 3658)
 144" × 72" (3658 × 1829)
 Multiple section: Unlimited

Options

- Factory finish:
 - High Performance Fluoropolymer - 100% resin Newlar®/ 70% resin Kynar®
 - Baked Enamel
 - Clear Anodize
 - Integral Color Anodize
 - Prime Coat
- Welded construction.
- Hinged frame.

Ratings

Free Area: [48" × 48" (1222 × 1222) unit]: 6.2 ft² (0.58 m²)
 38.8%

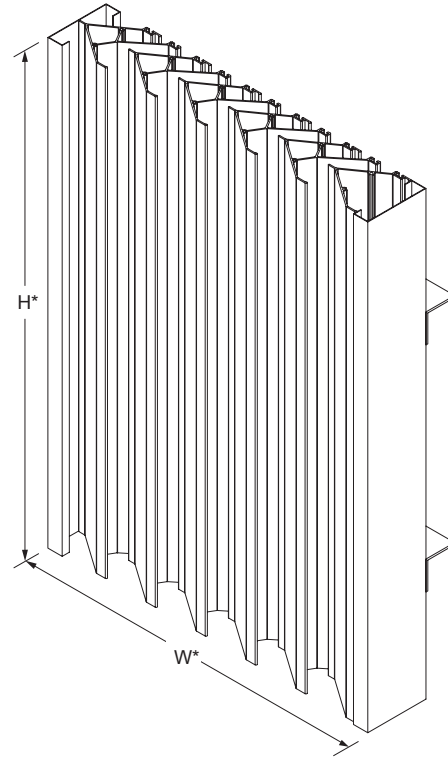

Model **VV-400**
 (standard)

*Dimensions furnished
 approximately 1/2" (13) undersize.

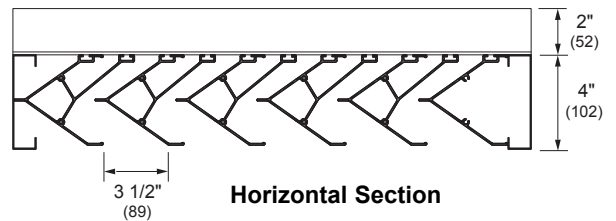

Horizontal Section

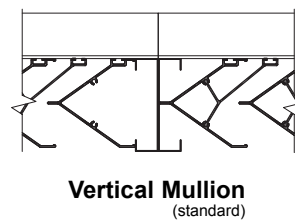

Vertical Mullion
 (standard)

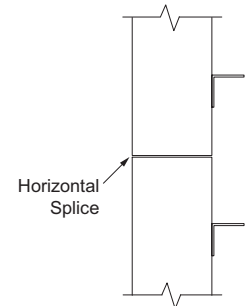

Horizontal Mullion
 (standard)